

# User Friendly Heating Systems for Low energy and Passive Multi Family Buildings

*Wolfgang Streicher*

*Institute of Thermal Engineering, Graz University of Technology*

*Inffeldgasse 25/B, A-8010 Graz*

*Tel: +43-316-873-7306, Fax: +43-316-873-7305,*

*E-Mail: [streicher@iwt.tugraz.at](mailto:streicher@iwt.tugraz.at), [heimrath@iwt.tugraz.at](mailto:heimrath@iwt.tugraz.at)*

## **Additional authors**

*Thomas Mach, Richard Heimrath, Karin Schweyer, Robert Kouba,*

*Institute of Thermal Engineering, Graz University of Technology, Austria*

*Alexander Thür, Dagmar Jähnig, Irene Bergmann,*

*Arbeitsgemeinschaft ERNEUERBARE ENERGIE, AEE INTEC, Austria*

*Jürgen Suschek-Berger, Harald Rohrer,*

*Interuniversitäres Forschungszentrum für Technik, Arbeit und Kultur, IFZ, Austria,*

*Helmut Krapmeier, Energieinstitut Vorarlberg, Austria*

## **Introduction**

The energy demand of new buildings has been decreased significantly during the last 25 years. This is due to the development of new building materials and building technology. Whereas 10 years ago common windows had a U-value of 3 W/(m<sup>2</sup>K) today's U-values are half of this at the same price. Similar developments have been achieved for other building materials which results in a specific energy demand of only one sixth (50 kWh/m<sup>2</sup>a) of today's buildings compared to buildings 30 years ago without additional costs. With little higher investment cost the energy demand can be decreased even further.

Low energy buildings (or passivehouses) have different demands for the heating systems than conventional buildings. This paper deals with these demands and an analysis of various heating systems with respect to end-use and primary energy demand, greenhouse relevant emissions, heat delivery costs (including capital costs) and qualitative criteria.

The passivehouse is defined by

Max. 15 kWh/m<sup>2</sup>a space heat demand (with ventilation system with air heat recovery)

Max. 42 kWh/m<sup>2</sup>a total end use energy demand including electricity for HVAC and others

Max. 120 kWh/m<sup>2</sup>a total primary energy demand

The main goal was the development of a comprehensive evaluation method for heating systems for buildings insulated according to passivehouse criteria.

This project was financed in the frame of the Austrian Research Initiative „Building of the Future“ of the Federal Austrian Ministry of Transportation, Innovation and Technology (BMVIT).

# Methodology

Two passive houses out of the CEPHEUS project (CEPHEUS 1, 2002, CEPHEUS 2, 2002) were simulated using the measured or evaluated data (climate, electricity demand, user behaviour concerning indoor temperature, ventilation, etc.). The results were compared to the measurements (Thür, 2002). With this approach, it was assured, that the reference buildings for the comparison are behaving similar to real passive houses.

A set of user behaviour patterns (ventilation, room temperature, presence, internal gains ..) was developed using a questionnaire in 53 apartments of low-energy multi family buildings, the measurements in the EC-project CEPHEUS, and an additional literature research. With this data two reference multi family buildings, insulated according to passivehouse criteria, were set up for the simulation.

In general different heat supply and heat delivery systems were described and analyzed in respect to their applicability in passive houses. Following this, nine different heating systems for such buildings (4 air heating and 5 water heating systems) with the heat sources decentralized air/air/water heat pump, central ground coupled heat pump, central pellets or gas burner, and decentralized pellets or tiled stove were described and qualitatively analyzed. All systems apart from the central ground-coupled brine/water heat pump was additionally calculated with an incorporated solar thermal plant (ref. Figure 1).

Four out of these systems (decentralized air/air/water heat pump, centralized ground coupled brine/water heat pump, centralized gas- and pellets burner, all systems apart the brine/water heat pump with and without solar thermal system, ref. Figure 1) were simulated in detail using the simulation tool TRNSYS. They were compared according to end-use and primary energy demand, CO<sub>2</sub>-equivalent emissions, heat delivery costs (including capital costs), and their sensitivity for changing user behaviour.

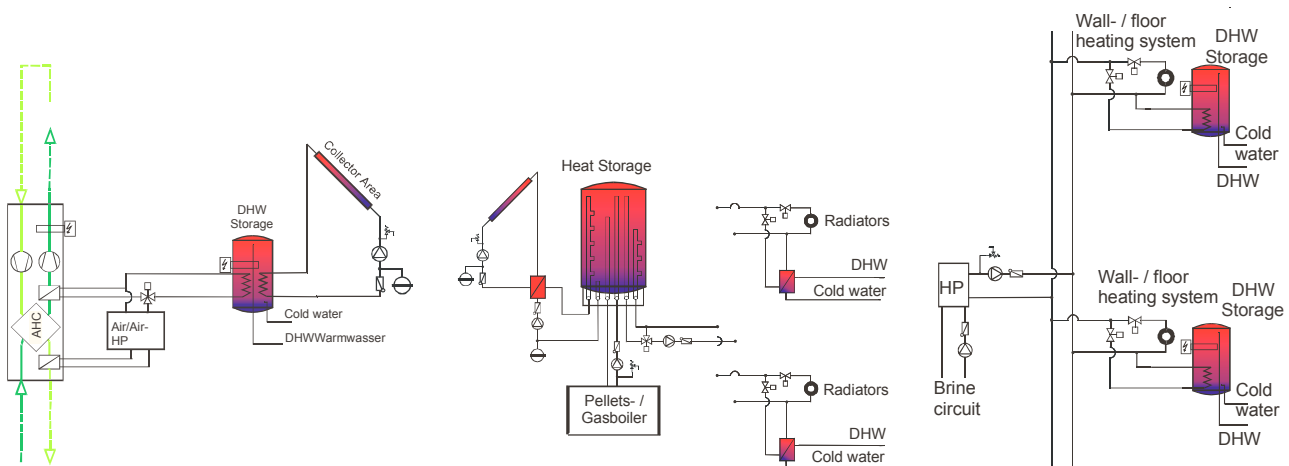

Figure 1 Hydraulic layout of the simulated heating systems (Streicher et al. 2004).

Additionally a sociological analysis using questionnaires and additional literature review was undertaken to evaluate the user demand and user acceptance for the various heating and heat delivery systems.

# Results

## Simulation of buildings insulated according to passive house criteria and reference user behaviour

It is possible to reach high accordance of the measured and simulated room air temperatures, when very detailed input data is available. Little differences i.e. in the user behaviour can alter the results significantly because the heat demand of the building is very small (ref. Table 1). An increase of the room set temperature from 20°C to 25°C increases, for example, the space heating energy demand by over 50% (with all other parameters fixed).

Table 1 Influence of user behaviour on the space heat demand (Streicher et al. 2004).

	Variation of user behaviour				Space heat demand		
	Electr. demand	People in appartm.	Room temperature	Air exchange rate	Space heat demand	Difference to base case	
	kWh/(d app)		°C	[1/h]	kWh/(m <sup>2</sup> a)	kWh/(m <sup>2</sup> a)	%
3 App base.	7	4	22,5	0.4	44.5	Base case	
3 App 20°C	7	4	20	0.4	34.9	-9.6	-22
3 App 25°C	7	4	25	0.4	54.8	+10.3	+23
3 App ex 1	3.5	2	25	0.8	100.7	+56.2	+126
3 App ex 2	15	6	20	0.2	11.6	-32.9	-74

App. : appartement

For detailed simulations and comparisons the user behaviour taken from standards is not sufficient. Even user profiles evaluated from questionnaires are sometimes not accurate enough (this is especially true for the ventilation by windows). Figure 2 shows the examples for the daily distribution of persons in the apartment and the electricity demand other than HVAC system chosen in this study.

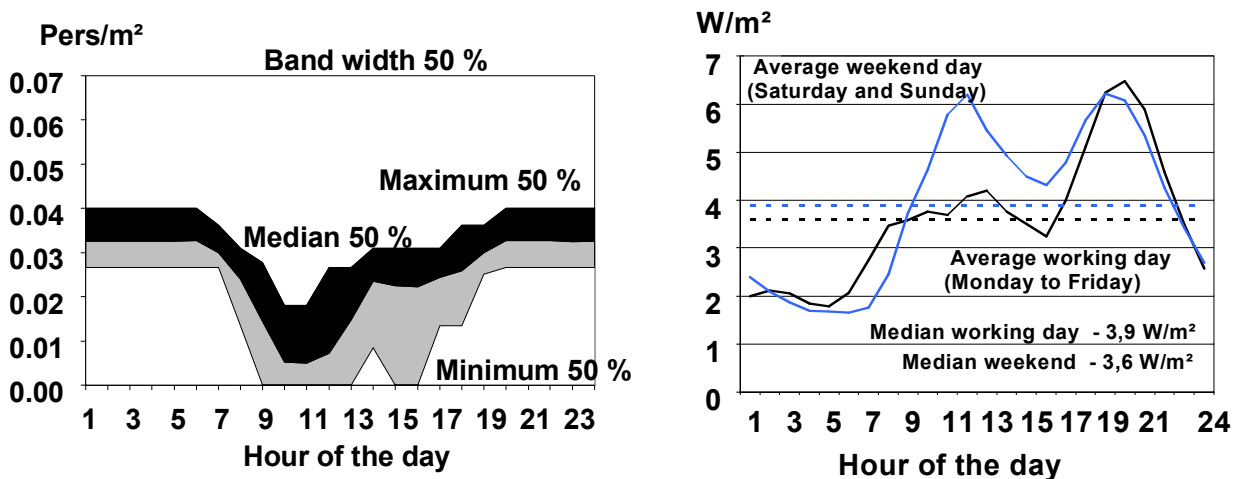

Figure 2 Average daily distribution of persons in the apartment (left) and electricity demand other than HVAC-system (right) (Streicher et al. 2004).

## Heating systems for buildings insulated according to passive house criteria

Heating systems for buildings insulated according to passive house criteria have to meet other requirements than heating systems for conventional buildings. Possible heat delivery systems are pure air heating systems (if the space heat demand for transmission and infiltration lays below  $14 \text{ W/m}^2$ ) as well as all kinds of water systems (radiator, floor-, and wall heating systems). The room-side temperatures of the windows and walls to the ambient are always relatively high in such well insulated buildings, which results in a good indoor climate. Nine different heating systems (space heating and domestic hot water) were described and analyzed qualitatively. One of the main results of the sociological questionnaire was, that in multi family buildings the type of the heating system is not seen as relevant as long as it works, is simple to be used, has no failures, and little maintenance costs (ref. Figure 3). Problems with the acceptance occur for not optimal planned or mounted systems (dimensioning, control, noise etc.) no matter which type of system.

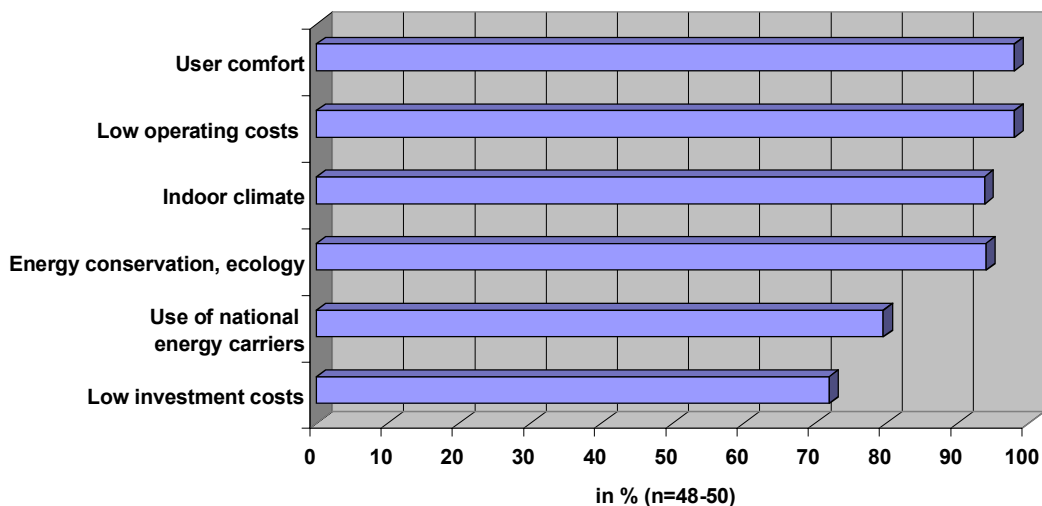

Figure 3 Importance of issues for the heating systems (questionnaire to residents in multi family low-energy and passive houses (Streicher et al. 2004).

## Simulation of the reference plants

Besides the user behaviour additional reference conditions were defined. The room temperature for the simulations was for example set to  $22.5^\circ\text{C}$  according to the results of the questionnaire. The DHW demand was defined with 6 minutes values from a tool developed by Jordan and Vajen, 2001 with in average  $50 \text{ l/person,d}$  at  $45^\circ\text{C}$ .

Detailed energy balances were calculated for all systems. Figure 4 shows as an example the energy flows within the decentralized air/air/water heat pump of Figure 1 left. In Figure 5 the energy balances for the buildings with 3 flats and the base case for all systems are shown. There are two bars per system, one showing the heat input and the other the heat demand, which is covered by all systems.

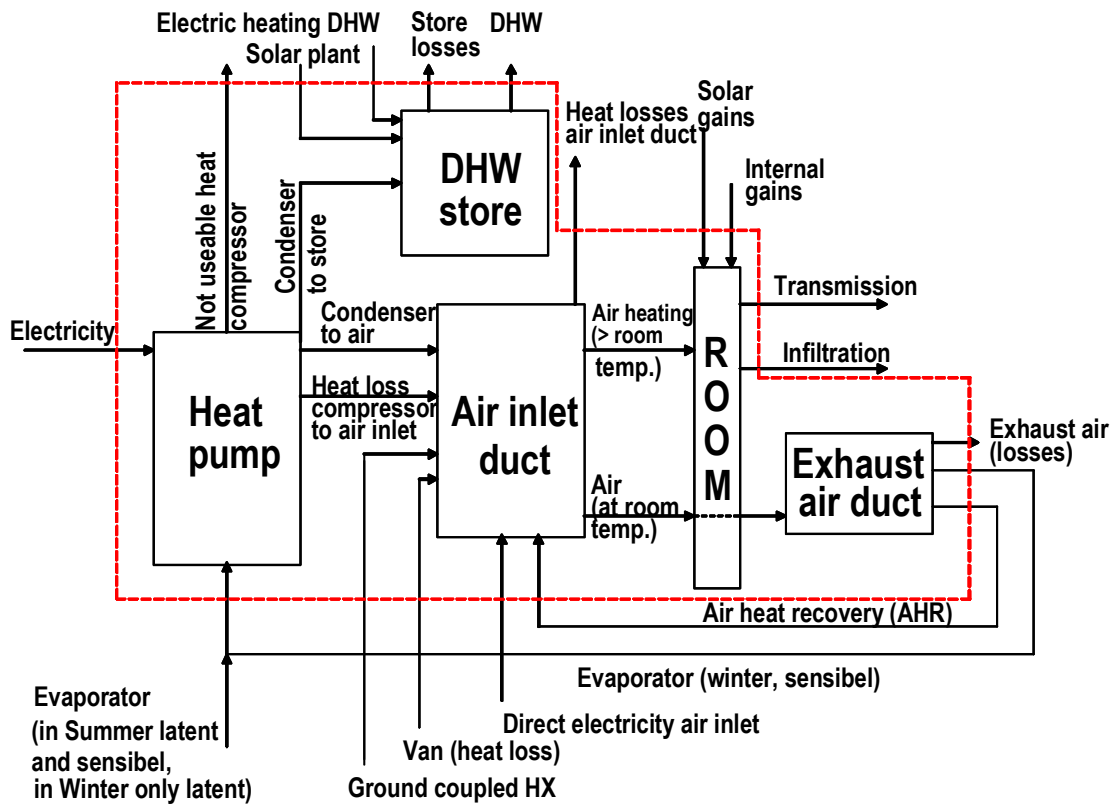

Figure 4 Energy flow of the decentralized air/air/water heat pump (Streicher et al. 2004).

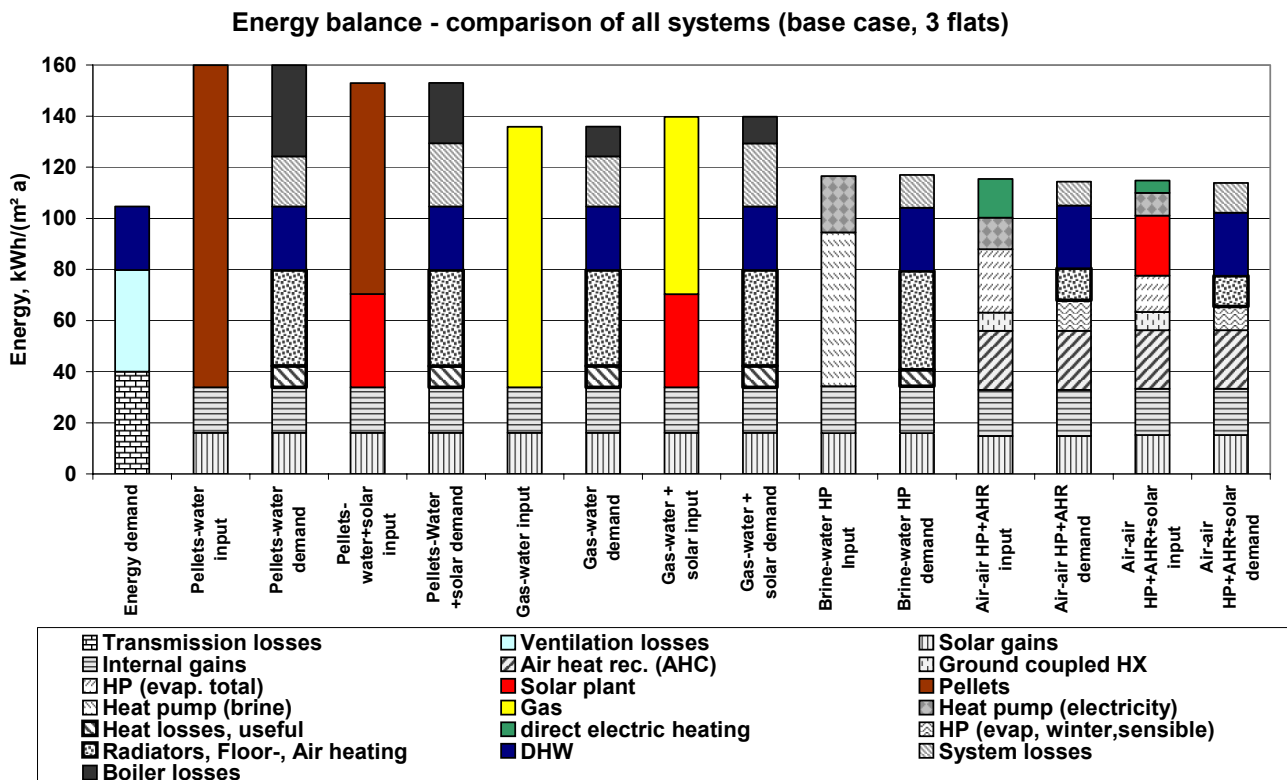

Figure 5 Energy balance – comparison of all systems (base case, 3 flats) with electricity only for HVAC system (Streicher et al. 2004).

The systems were compared according to end-use and primary energy demand, CO<sub>2</sub>-equivalent emissions, heat delivery costs (including capital costs), and their sensitivity for changing user behaviour. The primary energy demand and the CO<sub>2</sub> equivalent emissions were calculated using data from different literature (GEMIS 4.1,2002, Neubarth, Kaltschmitt, 2000, Kaltschmitt et al., 2003). The cost data was taken from the same literature as well as offers and questionnaires in companies.

The lowest energy demand could be found for the decentralized air/air/water heat pump system with solar thermal collectors, followed by the centralized ground-coupled brine/water heat pump equally to the decentralized air/air/water heat pump system without solar thermal system. The lowest greenhouse gas emissions were found for the centralized pellets system. The lowest heat delivery cost has the centralized gas-burner system without solar plant; the highest were found for the decentralized air/air/water heat pump system with solar thermal collectors. This system includes the controlled ventilations system, which would have to be paid separately for the other systems.

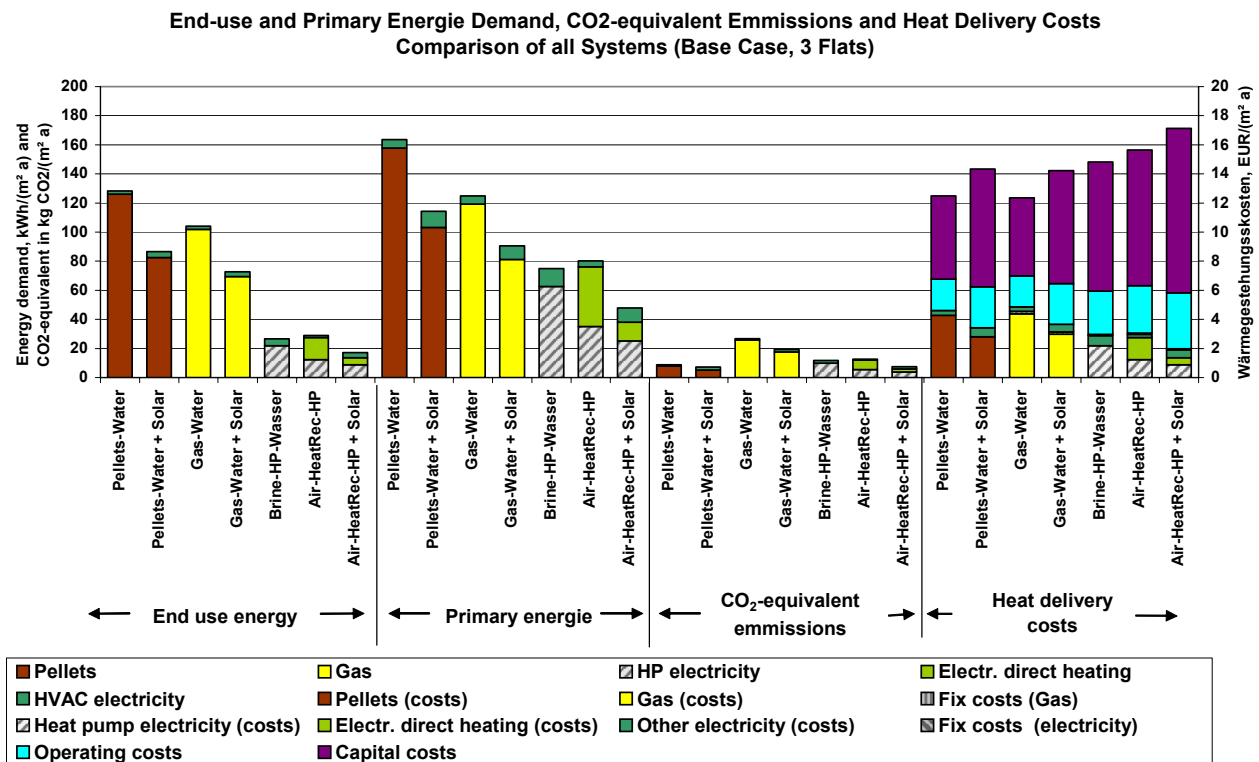

Figure 6 End-use and primary energy demand, CO<sub>2</sub>-equivalent-emissionen and heat delivery costs of the simulated heating systems with only HVAC electricity (base case, reference building 1, 3 flats)

The electricity demand of the building apart from the HVAC system is very relevant for the total primary energy demand. In the CEPHEUS (2001) project it was found with 3.3 W/m<sup>2</sup> (29.0 kWh/m<sup>2</sup>a). In the passivehouse calculation tool (PHPP 1999) it is given with 2.1 W/m<sup>2</sup> (18.4 kWh/m<sup>2</sup>a). With the data from CEPHEUS no heating systems matches the criteria of 42 kWh/m<sup>2</sup> a end-use energy demand. With the PHPP approach all heat pump systems are close to that value, the decentralized air/air/water heat pump with solar system lays with 36 kWh/m<sup>2</sup>a clearly below. As this electricity demand is not strongly

coupled to the heating system, it was skipped from the newest calculations for passive houses in Germany.

Additionally to the base case two extreme scenarios were defined (ref Table 1). For the high energy demand system (ex 1) the DHW temperature was set to 60°C, for the low heat demand scenario (ex 2) it was reduced to 30 l/person,d at 45°C. For the high heat load scenario all systems can not completely cover the heat demand. The highest mismatch between demand and delivery for this extreme scenario has the decentralized air/air/water heat pump because of its limited heating capacity (air exchange rate of 0.55, maximum air inlet temperature of 50°C).

In a last comparison two heating up tests at cold winter conditions were simulated

- 4 hour high ventilation phase (air exchange rate of 4) with heating system running (windows open)
- 15 days temperature setback to 15°C (vacation) and heating up period (Figure 7).

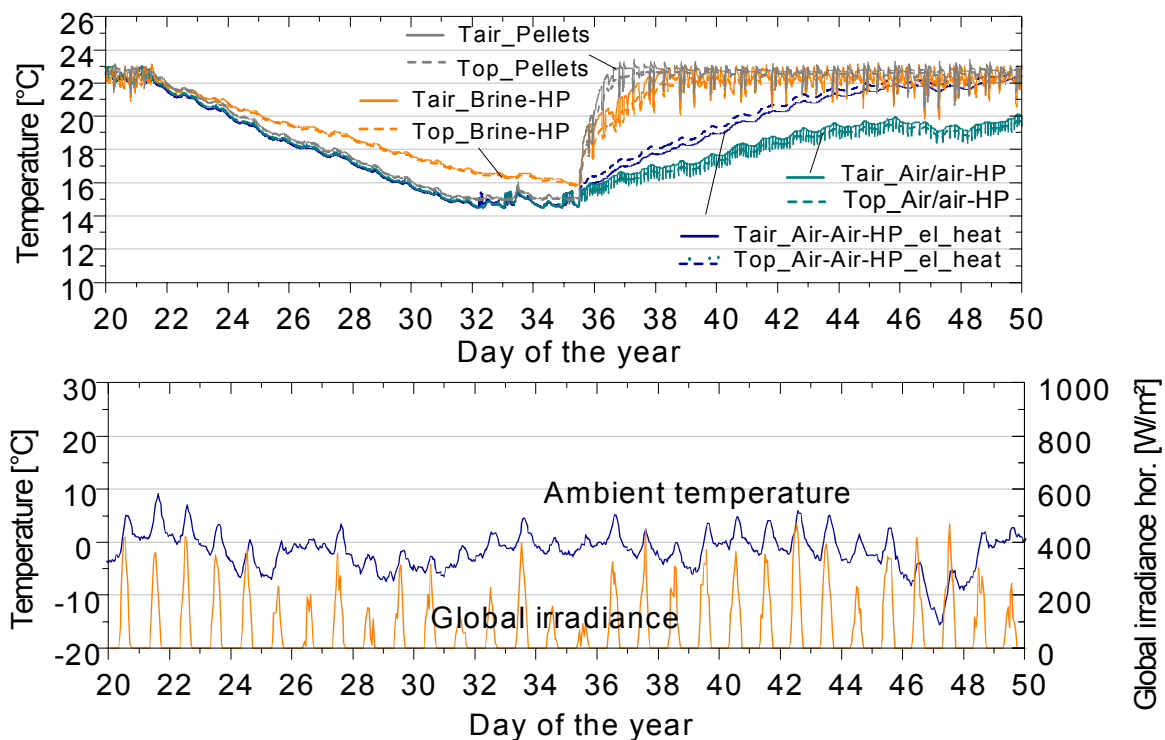

Figure 7 Course of operative (Top), air - (Tair), ambient temperature, global irradiance on horizontal and air exchange rate for the different heating systems (pellets, brine-water HP, Air/air/water HP und Air/air/water-HP with additional electric heater in the air inlet), 15 days temperature setback to 15°C, 3 flats )

For this heating up tests the limited heating capacity of the air heating systems becomes visible in Figure 7. With additional electric heater in the air inlet they need about 9 days to reach the required temperature. For heating up the floor heating system of the brine/water heat pump system reacts slower than the radiators, but the cooling needs also longer.

Table 2 summarizes the relevant data of all systems.

No significant difference could be found in the heating systems for the two reference buildings.

*Table 2 Summary of quantitative and qualitative simulated data of all systems*

		Pwo S	PwS	Gwo S	GwS	BWP	Air woS	Air wS
<b>Base case</b>								
Space heat demand	kWh/m <sup>2</sup> a	45.9	45.9	45.9	45.9	45.1	48.6	48.1
DHW demand	kWh/m <sup>2</sup> a	24.9	24.9	24.9	24.9	24.9	24.9	24.9
End-use energy demand								
Pellets/Gas	kWh/m <sup>2</sup> a	126	82.5	102	69.4			
Electr. for heating	kWh/m <sup>2</sup> a					22.0	27.5	13.7
Electr. other	kWh/m <sup>2</sup> a	2.2	4.1	2.1	3.4	4.6	1.5	3.6
Primary energy demand	kWh/m <sup>2</sup> a	163	114	125	91	75	80	45
CO <sub>2</sub> -equiv.-emissionens	kg/m <sup>2</sup> a	8.9	7.3	26.8	19.4	11.9	12.7	7.6
Heat delivery costs	EUR/m <sup>2</sup> a	12.5	14.3	12.4	14.2	14.8	15.6	17.1
Medium deviation of room temp. during heating	°C	±0.3	±0.3	±0.3	±0.3	±0.5	±0.4	±0.4
4 hours winter window open time of reheating Top=22°C	h	3	3	3	3	6	18	18
14 days winter temp. set back to 15°C time of reheating Top=22°C	d	1	1	1	1	3	9	9
<b>Extreme scenario high heat load</b>								
Space heat demand	kWh/m <sup>2</sup> a	101	101	101	101	101	101	101
Not covered heat load	kWh/m <sup>2</sup> a	5.1	4.6	5.1	5.0	8.2	17.7	19.8
Heat delivery costs	EUR/m <sup>2</sup> a	15.5	17.3	15.4	17.2	17.4	19.2	21.3
<b>Extreme scenario low heat load</b>								
Space heat demand	kWh/m <sup>2</sup> a	13.8	13.8	13.8	13.8	15.2	15.2	15.2
Heat delivery costs	EUR/m <sup>2</sup> a	10.7	12.8	10.5	12.5	13.8	14.8	16.3

PwoS –system 8, central pellets burner without solar plant  
PwS – system 8, central pellets burner with solar plant  
GwoS – system 8, central gas burner without solar plant  
GwS – system 8, central gas burner with solar plant  
BWP – system 6, central brine-water heat pump with decentralized DHW stores  
Air woS - system 1, small decentralized air/air/water heat pump without solar plant  
Air wS – system 1, small decentralized air/air/water heat pump with solar plant  
Top operative room temperature (median of room air temperature and temperature of the surrounding surfaces)

## Conclusion

Generally all analyzed heating systems fulfil the user demands, therefore it cannot be said that there is a „winner“. Each system has its own specifications and pros and cons and the total evaluation is depended on the type and the surrounding conditions of the building and the users. The report summarized in this paper lists all the criteria and gives the user the opportunity to make his own decision.

The full study can be downloaded from  
<http://www.hausderzukunft.at/> or  
<http://wt.tu-graz.ac.at/de/ag/solar/projekte.htm>



# Literature

**CEPHEUS 1 (2002)**, Krapmeier, H., Müller, E., CEPHEUS – Projektinformation Nr. 24, Reihenhäuser Hörbranz, Energieinstitut Vorarlberg, Dornbirn

**CEPHEUS 2 (2002)**, Krapmeier, H., Müller, E., CEPHEUS – Projektinformation Nr. 23, Mehrfamilienhaus Egg, Energieinstitut Vorarlberg, Dornbirn

**Gemis 4.1 (2002)**, Globales Emissions-Modell Integrierter Systeme, Ökoinstitut e.V., Freiburg, Deutschland, <http://www.oeko.de/service/gemis/de/index.htm>

**Jordan, U., Vajen, Klaus (2001)**, Influence Of The DHW Load Profile On The Fractional Energy Savings: : A Case Study Of A Solar Combi-System With TRNSYS Simulations, Solar Energy, Volume 69, Supplement 6, July-December 2001, Pages 197-208

**Kaltschmitt, M., Wiese, A., Streicher, W. (2003)**, Erneuerbare Energien, Systemtechnik, Wirtschaftlichkeit und Umweltaspekte, 3. Auflage, Springer.

**Neubarth, J., Kaltschmitt, M. (2000):** ), Erneuerbare Energien für Österreich, Springer

**PHPP, (1999)**, Passivhaus Projektierungs Paket, Passivhaus Institut Darmstadt, Deutschland

**Streicher, W., Mach. Th., Heimrath, R., Kouba, R., Thür, A., Jähnig, D., Bergmann, I., Suschek-Berger, J., Rohrer, H., Krapmeier, H. (2004)**, Benutzerfreundliche Heizungssystem für Niedrigenergie- und Passivhäuser, Endbericht und Leitfaden zum gleichnamigen Projekt in der Forschungsausschreibung „Haus der Zukunft“ im Auftrag des BMVIT, Hrsg.: Institut für Wärmetechnik, TU Graz.

**Thür A. (2002)**, CEPHEUS – Austria, Erfahrungen und Ergebnisse aus der Messbegleitung, Alexander Thür, Arbeitsgemeinschaft Erneuerbare Energie, AEE INTEC, Gleisdorf, Vortrag in Basel 2002